

## Users Manual of Household Gas Cooktop

This Manual applies to embedded household Gas Cooktop

- Before operating, please read this Manual carefully, and keep it properly.
- The pictures in this Manual are for reference only.

## Foreword & Contents

### Foreword

“Beautiful life starts from your kitchen”. Thanks for purchasing Ika kitchen appliances. Midea kitchen appliances undertake the social mission to provide beautiful kitchen lives for mankind, and Midea is committed to becoming the best kitchen life solution supplier in the world. We adhere to the purpose of quality first and customer foremost. If you have any comments and suggestions, please don't hesitate to contact us, and we will provide perfect services according to your needs.

Warning: Before installing and using, please read this Manual carefully, and get familiar with the safety precautions in order to use it properly.

Note: The appearance and structure of our products are subject to change without prior notice.

### Contents

Foreword	2
Product Diagrams	3
Specifications and Parameters	3
Safety Instructions	4
Installation Method	5
Method of use	8
Cleaning & Maintenance	10
Troubleshooting	11
Statement of Environmental Impact	12
Packing List	12
Warranty Information	13

## Product Diagrams

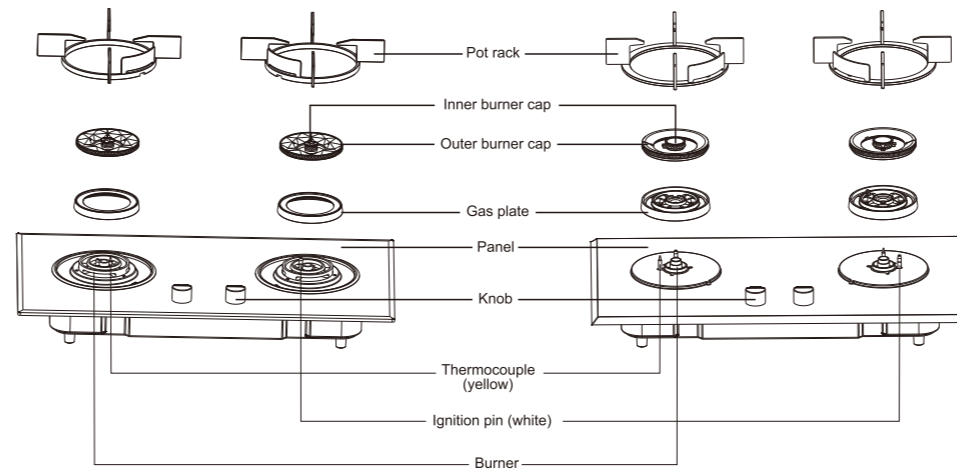

★ Note: Above figures are structure diagrams of the product. The figures are used to identify parts location. Please refer to the product for the actual appearance.

## Specifications and Parameters

Model	IKA-2D/SV	IKA-2R/SV	IKA-2C/SV
Gas category	LPG 20Y	LPG 20Y	LPG 20Y
Rated gas pressure	2800Pa	2800Pa	2800Pa
Rated heat load	See nameplate on the cooktop		
Power supply	DC 1.5V		
Weight	See details on the packing case		
Dimension	See details on the packing case		

★ Note: Refer to the mark on the nameplate of the cooktop for the rated gas pressure.

## Safety Instructions

### Caution



Low pressure regulator



Medium/high pressure regulator



- ◆ Be sure to use appropriate pressure regulator. The cooktop is a low pressure gas appliance. Only household pressure regulators in compliance with national standards can be used. Do not use medium pressure or high pressure regulators, or else it may cause hazards.
- ◆ Do not place any flammable or explosive materials (gasoline, alcohol, fireworks, and high-pressure spraying can) near the cooktop, or else it may cause fire or explosion.
- ◆ Do not put any acidic or alkaline materials on the cooktop in order to avoid corrosion.
- ◆ Do not put any knife, fork, spoon or other metal objects on the cooktop to avoid burn due to heating.
- ◆ If unattended, do not let children use or approach the heating cooktop.
- ◆ Do not impact the panel with heavy object.

### Caution

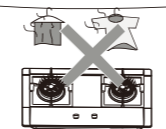
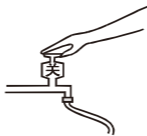

Air circulation

- ◆ While using the cooktop, do not go out or sleep. Turn off the switch knob and the master gas valve after using. Before sleeping or going out, check if the switch is turned off again.
- ◆ While using the cooktop or the flame is just turned off, do not touch the burner cap, pot rack or panel with hands in order to avoid burn.
- ◆ The cooktop can be used for cooking and boiling water. Do not use it to dry towels or clothes in order to avoid accidents.
- ◆ While using the cooktop, be sure to maintain appropriate ventilation to avoid health hazard caused by carbon monoxide produced by the cooktop in the closed kitchen.

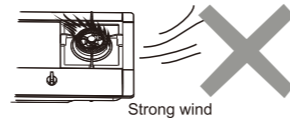

- ◆ Do not use the cooktop in the places blown by strong wind directly.
- ◆ The flameout protection device of the cooktop can only prevent gas leakage caused by wind blowing or soup spill. Please use the cooktop properly to avoid leakage due to other reasons.

◆ **If gas leakage is detected, be sure to**

- a. Stop using the Gas Cooktop immediately, turn off the master valve, open the door and window for ventilation, and contact local After-sales Service Center or gas company to check the reason and eliminate the problem.
- b. Before the gas leakage is eliminated, do not ignite or turn on electrical equipment, do not handle the power plug, and do not use mobile phone on site, or else open flame or electric spark will ignite the gas and cause fire or explosion.

## Installation Method

### Preparation

GAS HOB	
Model	IKA-2D/SV
Gas Type	LPG
Rated Pressure(Pa)	2800
Heat Flow(kW)	5.0/5.0
Product Size(mm)	780x450x145
S/N/O	IKA1806CC0001GH

- ◆ Check if the used gas category and rated gas pressure comply with the mark on the nameplate, and do not use if not.
- ◆ Refer to the structure diagrams and check if the parts of the cooktop are complete and intact.

### Installing cooktop feet

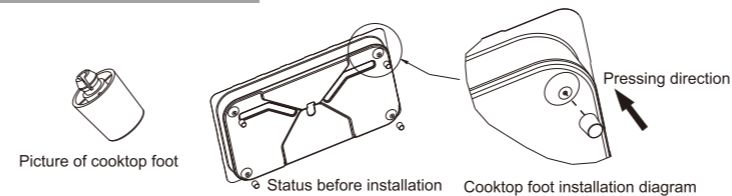

- ◆ If the embedded cooktop is used as a desktop cooktop, as shown in the picture, align the clips of the cooktop feet to the mounting holes in the four corners in the bottom of the cooktop, and push to clamp on the bottom shell. After installation, pull the cooktop feet to check if the installation is secure.

### Installing battery or adapter

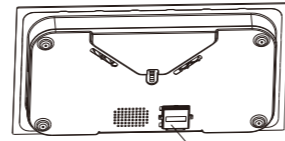

Battery compartment  
(applies to products using battery)

- ◆ The battery compartment is in the bottom of the cooktop. Please insert the battery according to the polarity indicated on the battery compartment.

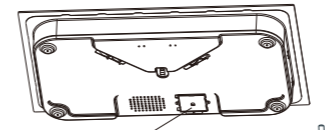

Adapter interface  
(applies to products using mains supply)

Adapter (applies to products using mains supply)

- ◆ The adapter is in the bottom of the cooktop. Please insert the adapter into the adapter interface of the cooktop, and then plug the adapter into the power outlet.
- ◆ For products that use dual power supply:  
If the mains power supply isn't connected and only battery is used, the cooktop can be ignited, but the gas detector, electronic timing and luminous knob are unavailable. If the mains power supply is connected but battery isn't used, all functions of the cooktop work normally. If the mains power supply is connected and battery is used, all functions of the cooktop work normally.

### Requirements on installation position

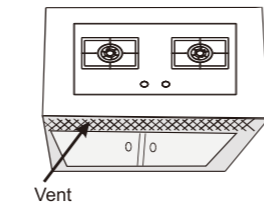
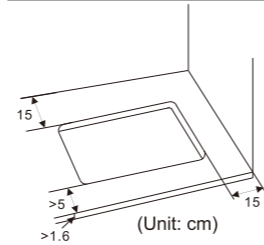

- ◆ The cooktop should be installed in places with proper ventilation. If LNG cylinder is used, the distance from the cooktop and the cylinder should be greater than 100cm. At least 100cm space should be retained above the cooktop. If exhaust hood is installed, retain the space according to the installation requirements of the exhaust hood. The distance from the cooktop opening to the back wall should be not smaller than 15cm in order to avoid interference between wok and the back wall or exhaust hood. The distance from the cooktop opening to the surrounding walls or objects should be not smaller than 15cm.
- ◆ If the cooktop is installed in the cupboard, the cupboard door should have one or several vents that connect to the cooktop bottom and the total area should be not smaller than 100cm<sup>2</sup>, in order to keep air circulation in the cupboard, ensure sufficient oxygen supply when the cooktop is working, ensure that a small amount of gas leaked due to improper installation or poor sealing of the gas inlet can be evacuated naturally and avoid accidents. To avoid rodents or insects entering the cupboard or the cooktop, please install metal mesh on the vents.

### Installing the cooktop

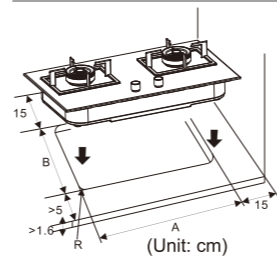

- ◆ Take out the cutout template from the packing case, drill holes in the cooktop according to the instructions of the cutout template and required size, and then put the cooktop in the mounting hole horizontally until the bottom of the cooktop panel fits the table (as shown in the figure, A, B and R are length, width and fillet size of the cutout template; the specific values follow the mark of the cutout template)

## Connecting gas pipe

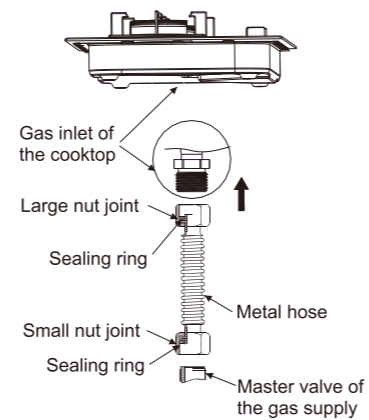
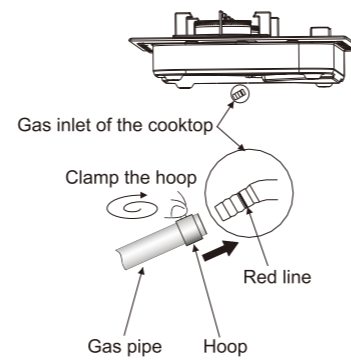
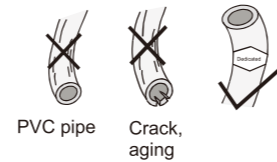

### ◆ Connecting with rubber pipe:

1. Select dedicated rubber pipe of  $\Phi 9.5\text{mm}$  inner diameter (or other custom specification) according to the gas inlet specification of the cooktop. The recommended length is 100~150cm. Do not use rubber pipes that have defects or aged.
2. Connect one end of the rubber pipe to the gas inlet of the cooktop to the red line, clamp the connection with a hoop to prevent leakage, and connect the other end to the master valve of gas supply.
3. Do not put the rubber pipe on the cooktop, and avoid compression and bending of the pipe.

### ◆ Connecting with metal hose:

Connect the larger nut joint of the metal hose to the gas inlet of the cooktop and tighten in place. Connect the smaller nut joint to the master valve of the gas supply, and also tighten in place.

### ★ Note:

The nut joints on both ends of the metal hose must have sealing rubber rings before installing and using.

### ◆ Check if the installed gas connector leaks:

Apply soapy water on connections of the gas pipe, and open the master valve; if air bubbles are produced, the pipe leaks; please close the master valve, tighten the clamp the gas pipe or the nut joint appropriately and try again until there is no leakage. Check the connections regularly in later use.

## Method of use

### Ignition operation

1. Turn all knobs to "I" position, and open the master valve of the gas supply.
2. Press the knob, turn left counterclockwise to the high heat position "III", and the flame is ignited automatically when the ignition pin clicks.

★ **Note:**

- a. If the cooktop you purchased isn't instant start series, please press the knob for 3-5 seconds when the flame is ignited (flameout protection system of the cooktop needs preheating for 3-5 seconds).

- b. If the cooktop you purchased is instant start series, release your hand when the flame is ignited.

★ **Tips:**

If the cooktop is used for the first time or hasn't been used for a long time, it is normal if it is difficult to ignite because the gas pipe has air residue. Please try several times to discharge the air until the flame is ignited normally. Do not remove the gas pipe to discharge the air.



### Adjusting fire power

Rotate the knob slowly as shown in the figure below to get desired fire power.

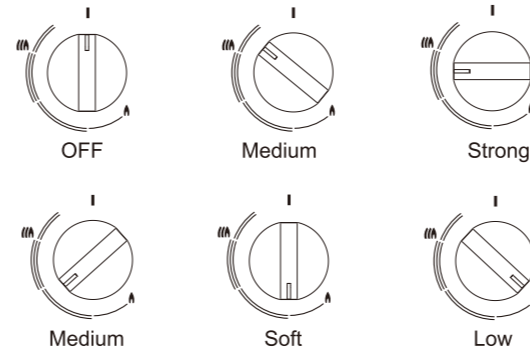
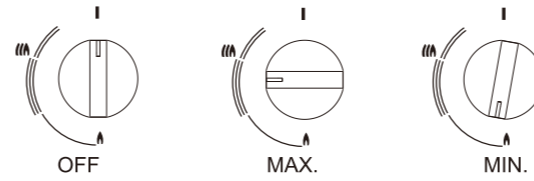

Remark: Please refer to the cooktop to check if it is general adjustment or accurate adjustment.

### Adjusting ventilation door

The adjusting plate of ventilation door is in the bottom of the cooktop, and is used to adjust the flame burning. Under normal conditions, the ventilation door of the cooktop has been adjusted properly, and the burning flame is light blue, clear and stable.

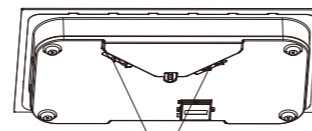

Position of adjusting plate of ventilation door

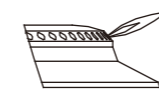

Normal blue flame

◆ **Adjusting method of ventilation door:**

Hold the handle of the adjusting plate of the ventilation door, lift about 1mm and then turn left or right. When the handle is turned to the left, the air inlet of the ventilation door is narrowed and the intake air quantity is reduced. When the handle is turned to the right, the air inlet of the ventilation door is expanded and the intake air quantity is increased.

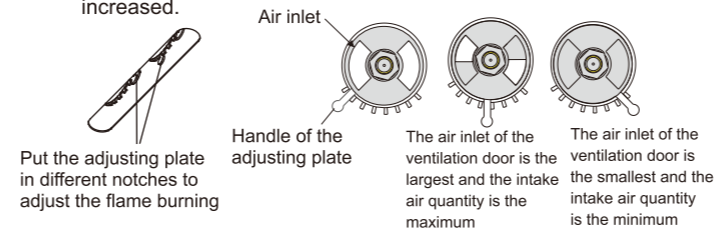

◆ If the flame is abnormal, please adjust according to the table below:

	Abnormal flame	Ventilation door adjusting method
	Flame breaks away from the fire hole or there is big noise when the flame extinguishes.	Narrow the air inlet of the ventilation door and decrease the intake air quantity
	Flame retracts into the burner, no flame or fuzzy flame on the burner cap, and accompanied by whirr	
	Flame is yellow	Expand the air inlet of the ventilation door and increase the intake air quantity

## Cleaning & Maintenance

- ◆ Regularly check if the rubber pipes are intact and if there is any aging or crack; replace the pipes regularly (once a year recommended).
- ◆ Before cleaning the cooktop, turn off the master valve of the gas supply and wait for the cooktop to cool down.
- ◆ Clean the counter and surrounding of the cooktop regularly (once a day recommended). Clean the cooktop surface with soft cloth and neutral (or dedicated) detergent; do not use steel ball or other hard objects.
- ◆ Clear the dirt on the burner surface, ignition pin and thermocouple surface with soft brush and neutral (or dedicated) detergent; do not use steel ball or other hard objects.
- ◆ Clear the carbon deposits in the inner and outer burner cap with thin sheet iron or steel needle to avoid blocking the fire hole and affecting normal use.
- ◆ After cleaning, install the gas plate, burner cap and pot rack in place (refer to the installation method).

## Troubleshooting

Failure	Cause	Solution
Can't ignite	The master valve is closed or gas is run out	Open the master valve or replace the gas
	Battery isn't installed, reverse or power insufficient	Install the battery properly or replace the battery
	Gas pipeline is mixed with air	Ignite repeatedly to discharge the air
	Rubber hose is bent or squashed	Straighten or replace the hose
	Safety system isn't preheated sufficiently	Ignite and hold the knob for 3-5 seconds
	Ignition pin has dirt in the tip	Clean
	Ignition pin isn't in proper position	Adjust the distance between the ignition pin and burner cap to 3-5mm
Gas leakage (smell gas)	Rubber pipe is aged, cracks or falls off	Replace or reconnect the rubber pipe
	Pipes are not connected properly	Check the tightness of the connections and connect properly (refer to "Connecting gas pipe")
Flame is red	Air humidity is too high, too much fume	Normal phenomenon
Flame is yellow	LNG in the cylinder is almost run out	Replace the LNG
	The fire hole of the burner cap is blocked	Clear the dirt
	The air inlet of the ventilation door is too small	Adjust the ventilation door to expand the air inlet (refer to "Adjusting ventilation door")
Flame breaks away from the fire hole or there is big noise when the flame extinguishes	The air inlet of the ventilation door is too big	Adjust the ventilation door to narrow the air inlet (refer to "Adjusting ventilation door")
Flame retracts into the burner, no flame or fuzzy flame on the burner cap, and accompanied by whirr	The burner cap and gas plate are not placed properly	Place the burner cap and gas plate properly; follow the positioning if available
	The air inlet of the ventilation door is too big	Adjust the ventilation door to narrow the air inlet (refer to "Adjusting ventilation door")
Hood doesn't start after igniting (applies to cooktops with hood-cooktop linkage function of models with L suffix)	The hood doesn't have hood-cooktop linkage function (model with L suffix)	Use the hood that has hood-cooktop linkage function
	Linkage function of the hood isn't turned on	Turn on the hood-cooktop linkage function
	The electrical control board of the cooktop is oxidized or burnt	Ask qualified personnel to replace

★ If the problem still can't be eliminated, please ask designated service department to repair.

## Statement of Environmental Impact

The company establishes, implements, and maintains environment management system in accordance with national standard. The environmental impacts of the products in use and after service life expires are as follows:





The paper boxes and plastic bags can be recycled, but foam can't be recycled and should be disposed of into dedicated trash can after unpacking.

The waste batteries can be recycled and should be disposed of into dedicated trash can, or else it will cause environmental pollution. The product in use will discharge CO, CO<sub>2</sub>, NOX and other waste gases.

Please keep ventilation of the room. Poor ventilation will cause the concentration of CO, CO<sub>2</sub>, NOX and other waste gases rising significantly, which will harm your health and cause hypoxia poisoning or even death.

Every product has its service life. Please scrap it according to national regulations. The scrapped product shall be sent to local collection station.

## Packing List

	Cooktop	1 set		Users Manual	1pcs
	Cutout template	1pcs		Cooktop feet	4pcs
	Clamp hoop	1pcs			

- Note:
1. Clamp hoop isn't provided for the areas using G1/2 screw.
  2. Auxiliary tine pot rack and small pot rack are optional for certain models.
  3. Certain models are not recommended for desktop cooktops, and cooktop feet are not provided.
  4. Adapter is only equipped for products using mains supply.

## Warranty Information

The free warranty doesn't cover the following cases, but we can provide charged services.

The authorized service outlets provide charged services for the following cases:

- (1) The damage is caused by improper handling, use, maintenance or storage;
- (2) The damage is caused by installation or maintenance in unauthorized service outlets (including installation or repair by the user);
- (3) The user can't offer valid invoice or proof of purchase, and can't proof the warranty period;
- (4) The invoice doesn't match the product or is altered;
- (5) The damage is caused by force majeure;
- (6) Beyond the warranty period;
- (7) The damage is caused in the environment (e.g. voltage, humidity, temperature, ventilation, etc.) in compliance with the Manual.

## Tips

---

- Before installing the product, drill vents in the cupboard with total area not smaller than 100cm<sup>2</sup> according to the “Requirements on installation position” in this Manual.
- The cooktop is a low pressure gas appliance. Please use appropriate pressure regulator. Do not use medium pressure or high pressure regulators, or else it may cause hazards.
- To ignite, press the knob to the bottom and rotate left for 90° to the ignition position; after igniting, hold the knob for 3~5 seconds before releasing (because the flameout protection system requires preheating).
- For first use, please ignite several times to discharge the air from the pipe.
- If the ignition sound is weak, please replace the battery. It is recommended to use high capacity alkaline battery to extend the operating time.

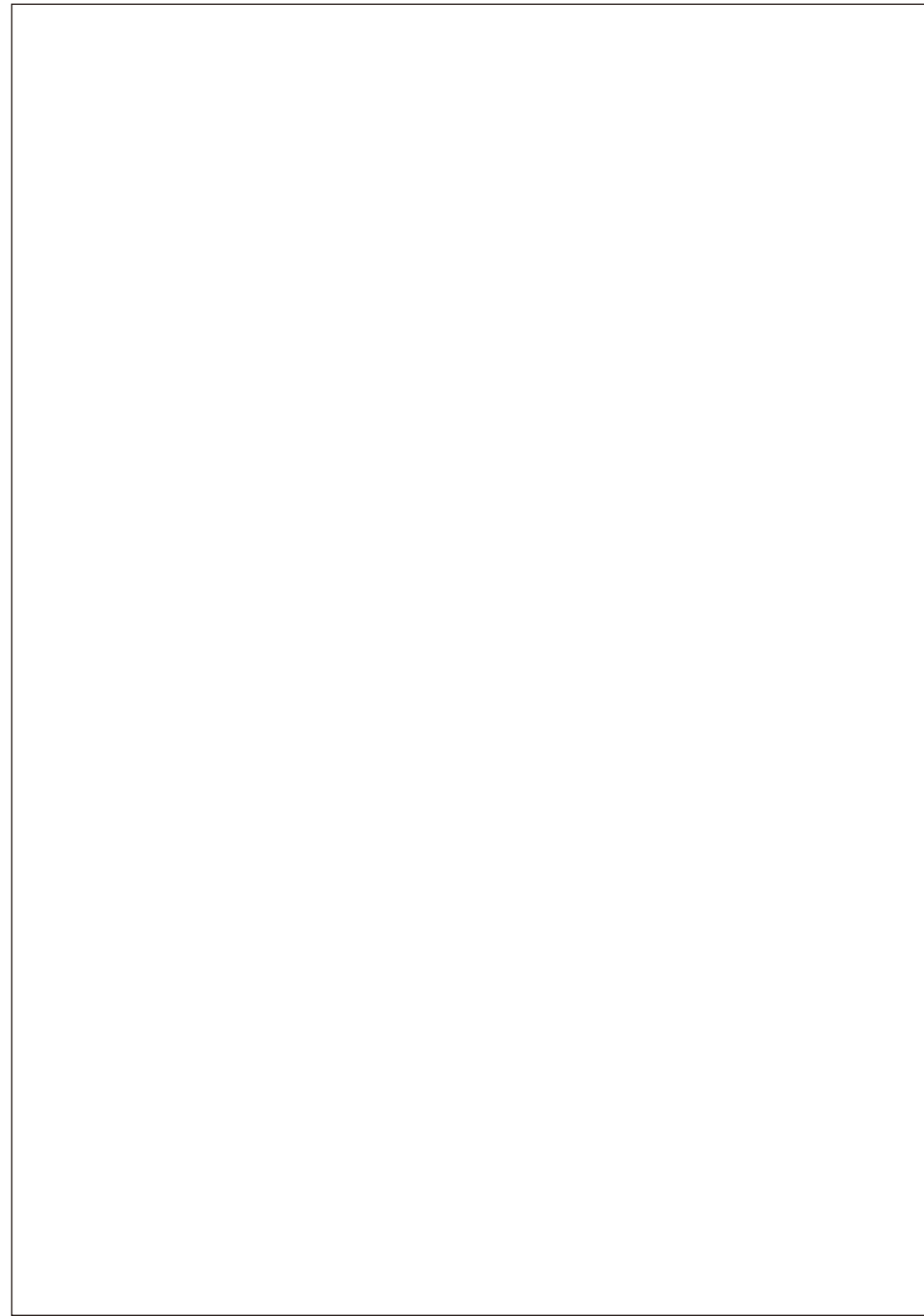

**HOME TYPE TRADING SDN BHD**  
LOT 1848-C, JALAN KPB 8, KG. BARU BALAKONG,  
43300 SERI KEMBANGAN,  
SELANGOR DARUL EHSAN, MALAYSIA.  
TEL: 03-8962 1848 FAX: 03-8961 8848